



Adda 247 Publications

BOOKS

<p>IBPS PO/CWE-VIII 20+ IBPS PO PRELIMS 2018 MOCK PAPER BASED ON LATEST PATTERN (English Medium) 2200 Questions with Detailed Solutions Previous Year's Papers of IBPS PO PRE 2017 & IBPS PO PRE 2016</p>	<p>20+ IBPS RRB MOCK PAPERS 2018 FOR PO & CLERK BASED ON LATEST PATTERN This Edition Includes: 10 IBPS RRB Mock Papers 6 IBPS RRB Previous Year's Papers 4 IBPS RRB Previous Year's Questions 2 IBPS RRB Previous Year's Solutions 1800+ Questions with Detailed Solutions Previous Year's Papers of IBPS PO PRE, IBPS RRB PRE, IBPS PO MAINS, IBPS RRB MAINS</p>	<p>A COMPREHENSIVE GUIDE FOR RAILWAYS EXAMS (हिंदी माध्यम) 5000+ प्रश्न 15+ Full-length Mocks of RRB Group 'D', RRB JE and RRB PO Main Paper समस्त विभागों के लिए 500+ प्रश्न 15+ टॉपिक विसंग प्रश्नसंग्रह सेट Important MCQs of All Divisions and General</p>	<p>A COMPREHENSIVE GUIDE FOR RAILWAYS EXAMS (English Medium) 5000+ Questions 15+ Full-length Mocks of RRB Group 'D', RRB JE and RRB PO Main Paper 500+ MCQs of General Science Topic-wise Questions & Practice Sets</p>	<p>50 BANK PO & CLERK 2016-18 (PREVIOUS YEARS' (MEMORY BASED) SOLVED MOCK PAPERS BOOK) (English Medium) 6800+ Questions with Detailed Solutions 18 Previous Year's Papers 20 Previous Year's Questions 6 Previous Year's Solutions 400+ Previous Year's Questions Bank 100+ Previous Year's Solutions Previous Year's Papers of IBPS PO PRE 2017 & IBPS PO PRE 2016</p>	<p>A COMPLETE BOOK FOR PUZZLES & SEATING ARRANGEMENT Ideal for Banking & Insurance Examinations like IBPS, SSC, IB, LIC, CLERK & Others. This Edition Includes: 1000+ Puzzles 1000+ Seating Arrangement Questions 1000+ Seating Arrangement Solutions 1000+ Seating Arrangement Questions 1000+ Seating Arrangement Solutions 1000+ Seating Arrangement Questions 1000+ Seating Arrangement Solutions 1000+ Seating Arrangement Questions 1000+ Seating Arrangement Solutions 1000+ Seating Arrangement Questions 1000+ Seating Arrangement Solutions</p>
<p>A COMPLETE BOOK FOR PUZZLES & SEATING ARRANGEMENT (हिंदी माध्यम में) 1000+ प्रश्नसंग्रह 1000+ समाधान 1000+ प्रश्नसंग्रह 1000+ समाधान 1000+ प्रश्नसंग्रह 1000+ समाधान 1000+ प्रश्नसंग्रह 1000+ समाधान 1000+ प्रश्नसंग्रह 1000+ समाधान</p>	<p>A COMPLETE BOOK ON DATA INTERPRETATION & ANALYSIS Ideal for Banking & Insurance Examinations like IBPS, SSC, IB, LIC, CLERK & Others. This Edition Includes: 1000+ Data Interpretation Questions 1000+ Data Interpretation Solutions 1000+ Data Interpretation Questions 1000+ Data Interpretation Solutions 1000+ Data Interpretation Questions 1000+ Data Interpretation Solutions 1000+ Data Interpretation Questions 1000+ Data Interpretation Solutions 1000+ Data Interpretation Questions 1000+ Data Interpretation Solutions</p>	<p>100 SSC CGL TIER-I / PRELIMS Previous Year's Papers & Mock Test Practice Book (English Medium) This Edition Includes: 1000+ Questions 1000+ Solutions 1000+ Questions 1000+ Solutions 1000+ Questions 1000+ Solutions 1000+ Questions 1000+ Solutions 1000+ Questions 1000+ Solutions</p>	<p>Ace REASONING A Complete Guide to Reasoning Aptitude for Banking & Insurance Examinations Ideal for IBPS, SSC, IB, LIC, CLERK & Others. This Edition Includes: 1000+ Reasoning Questions 1000+ Reasoning Solutions 1000+ Reasoning Questions 1000+ Reasoning Solutions 1000+ Reasoning Questions 1000+ Reasoning Solutions 1000+ Reasoning Questions 1000+ Reasoning Solutions 1000+ Reasoning Questions 1000+ Reasoning Solutions</p>	<p>Ace QUANT A Complete Guide to Quantitative Aptitude for Banking & Insurance Examinations Ideal for IBPS, SSC, IB, LIC, CLERK & Others. This Edition Includes: 1000+ Quantitative Questions 1000+ Quantitative Solutions 1000+ Quantitative Questions 1000+ Quantitative Solutions 1000+ Quantitative Questions 1000+ Quantitative Solutions 1000+ Quantitative Questions 1000+ Quantitative Solutions 1000+ Quantitative Questions 1000+ Quantitative Solutions</p>	<p>Ace ENGLISH A Complete Guide to English Language for Banking & Insurance Examinations Ideal for IBPS, SSC, IB, LIC, CLERK & Others. This Edition Includes: 1000+ English Questions 1000+ English Solutions 1000+ English Questions 1000+ English Solutions 1000+ English Questions 1000+ English Solutions 1000+ English Questions 1000+ English Solutions 1000+ English Questions 1000+ English Solutions</p>
<p>ऐस क्वांट समस्त विभागों के लिए समस्त विभागों के लिए समस्त विभागों के लिए समस्त विभागों के लिए समस्त विभागों के लिए समस्त विभागों के लिए समस्त विभागों के लिए समस्त विभागों के लिए समस्त विभागों के लिए समस्त विभागों के लिए</p>	<p>ऐस रीजनिंग समस्त विभागों के लिए समस्त विभागों के लिए समस्त विभागों के लिए समस्त विभागों के लिए समस्त विभागों के लिए समस्त विभागों के लिए समस्त विभागों के लिए समस्त विभागों के लिए समस्त विभागों के लिए समस्त विभागों के लिए</p>	<p>Ace SSC ARITHMETIC for SSC, Railway & Other Govt. Examinations Ideal for IBPS, SSC, IB, LIC, CLERK & Others. This Edition Includes: 1000+ Arithmetic Questions 1000+ Arithmetic Solutions 1000+ Arithmetic Questions 1000+ Arithmetic Solutions 1000+ Arithmetic Questions 1000+ Arithmetic Solutions 1000+ Arithmetic Questions 1000+ Arithmetic Solutions 1000+ Arithmetic Questions 1000+ Arithmetic Solutions</p>	<p>Ace SSC ARITHMETIC for SSC, Railway & Other Govt. Examinations Ideal for IBPS, SSC, IB, LIC, CLERK & Others. This Edition Includes: 1000+ Arithmetic Questions 1000+ Arithmetic Solutions 1000+ Arithmetic Questions 1000+ Arithmetic Solutions 1000+ Arithmetic Questions 1000+ Arithmetic Solutions 1000+ Arithmetic Questions 1000+ Arithmetic Solutions 1000+ Arithmetic Questions 1000+ Arithmetic Solutions</p>	<p>Ace SSC GENERAL INTELLIGENCE & REASONING for SSC, Railway & Other Govt. Examinations Ideal for IBPS, SSC, IB, LIC, CLERK & Others. This Edition Includes: 1000+ Intelligence Questions 1000+ Intelligence Solutions 1000+ Intelligence Questions 1000+ Intelligence Solutions 1000+ Intelligence Questions 1000+ Intelligence Solutions 1000+ Intelligence Questions 1000+ Intelligence Solutions 1000+ Intelligence Questions 1000+ Intelligence Solutions</p>	<p>Ace SSC ENGLISH LANGUAGE & COMPREHENSION BOOK for SSC, Railway & Other Govt. Examinations Ideal for IBPS, SSC, IB, LIC, CLERK & Others. This Edition Includes: 1000+ English Questions 1000+ English Solutions 1000+ English Questions 1000+ English Solutions 1000+ English Questions 1000+ English Solutions 1000+ English Questions 1000+ English Solutions 1000+ English Questions 1000+ English Solutions</p>
<p>Ace SSC GENERAL AWARENESS PART-I (History/Geography/Polity) Examinations for SSC, Railway & Other Govt. Examinations Ideal for IBPS, SSC, IB, LIC, CLERK & Others. This Edition Includes: 1000+ General Awareness Questions 1000+ General Awareness Solutions 1000+ General Awareness Questions 1000+ General Awareness Solutions 1000+ General Awareness Questions 1000+ General Awareness Solutions 1000+ General Awareness Questions 1000+ General Awareness Solutions 1000+ General Awareness Questions 1000+ General Awareness Solutions</p>	<p>Ace SSC GENERAL AWARENESS PART-II (PHYSICS / CHEMISTRY / BIOLOGY) Examinations for SSC, Railway & Other Govt. Examinations Ideal for IBPS, SSC, IB, LIC, CLERK & Others. This Edition Includes: 1000+ General Awareness Questions 1000+ General Awareness Solutions 1000+ General Awareness Questions 1000+ General Awareness Solutions 1000+ General Awareness Questions 1000+ General Awareness Solutions 1000+ General Awareness Questions 1000+ General Awareness Solutions 1000+ General Awareness Questions 1000+ General Awareness Solutions</p>	<p>BANKING AWARENESS eBook For SBI, IBPS, RBI Grade-B & Other Competitive Exams English Medium</p>	<p>Static General Awareness eBook for Bank, SSC, Railway & Other Competitive Exams ENGLISH MEDIUM</p>	<p>IT OFFICER HANDBOOK e-Books</p>	<p>A Comprehensive Guide To Crack Interview for IBPS PO 2018</p>

Visit: publications.adda247.com & store.adda247.com
For any information, mail us at publications@adda247.com

Solutions

S1. Ans.(b)

Sol.

- I. U#W(FALSE) II. D#W(TRUE)
 III. N©R(TRUE) IV. U©D(FALSE)

S2. Ans.(b)

Sol.

- I. B©P(FALSE) II. P\$E(TRUE)
 III. H\$L(FALSE) IV. E%B(FALSE)

S3. Ans.(a)

Sol.

- I. T\$Q(TRUE) II. J\$Q(TRUE)
 III. T#K(FALSE) IV. M©Q(FALSE)

S4. Ans.(c)

Sol.

- I. M\$R(FALSE) II. D#P(FALSE)
 III. L©P(TRUE) IV. D%M(FALSE)

S5. Ans.(d)

Sol.

- I. F\$D(FALSE) II. T\$W (FALSE)
 III. M©W(FALSE) IV. T\$M(TRUE)



Solutions (6-10):

Floor numbers	Persons
9	D
8	H
7	E
6	F
5	A
4	G
3	I
2	B
1	C

S6. Ans.(d)

S7. Ans.(e)

S8. Ans.(d)

S9. Ans.(c)

S10. Ans.(a)

Special Offer

adda247
test series

NIACL AO 2019

(Generalists)

PHASE-I

• 10 Full-Length Mocks

Bilingual

S11. Ans.(d)

Sol.

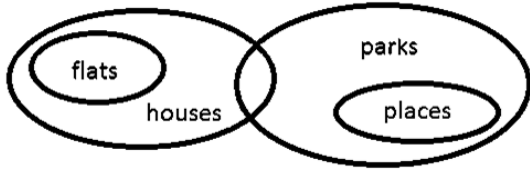

S12. Ans.(c)

Sol.



S13. Ans.(a)

Sol.

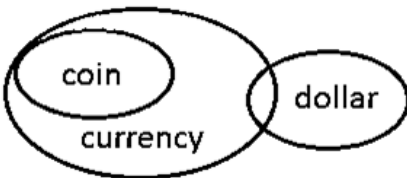

S14. Ans.(b)

Sol.



S15. Ans.(a)

Sol.

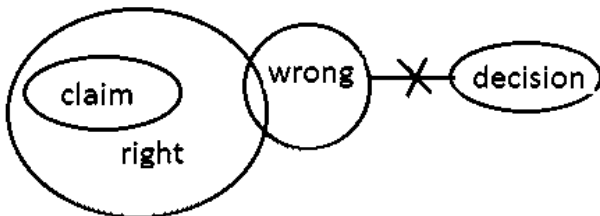

Solutions (16-20):

Day	Student	Color
Monday	D	Red
Tuesday	F	Black
Wednesday	E	White
Thursday	C	Blue
Friday	-----	-----
Saturday	A	Yellow
Sunday	B	Green

- S16. Ans.(b)
 S17. Ans.(b)
 S18. Ans.(b)
 S19. Ans.(a)
 S20. Ans.(d)

Solutions (21-25):

Word	Code
Agencies	lo
Rating	we
may	bg
exchange	ui
india	tr
credit	ij
board	te

- S21. Ans.(c)
 S22. Ans.(b)
 S23. Ans.(e)
 S24. Ans.(c)
 S25. Ans.(d)

S26. Ans.(d)

Sol. UDT IAT OOE UXO DUT

S27. Ans.(c)

Sol. TCR HAR OND TWN CTR

S28. Ans.(e)

S29. Ans.(a)

Sol. TCS HCS QNG TWQ CTS

S30. Ans.(c)

Sol. CST AHS ENO OTW CST

Solutions (31-35):

Floors	Persons
8	C
7	E
6	A
5	D
4	F
3	G
2	B
1	H

SBI PO PRIME 2019

With Video Solutions

85+ Total Tests

- ✓ 30 Full Length Mocks
- ✓ 7 + Previous Years Papers
- ✓ 30 Section Wise Practice sets
- ✓ 20 Topic wise sets
- ✓ eBooks

BILINGUAL



S31. Ans.(a)

S32. Ans.(b)

S33. Ans.(b)

S34. Ans.(e)

S35. Ans.(a)

Solution (36-40):

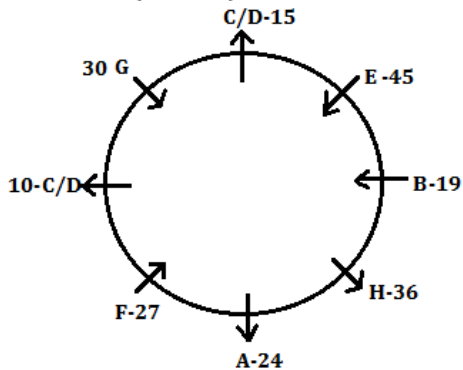

S36. Ans.(d)

S37. Ans.(e)

S38. Ans.(d)

S39. Ans.(c)

S40. Ans.(c)

Solution (41-43):

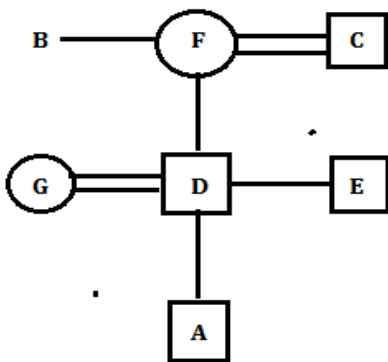

S41. Ans.(d)

S42. Ans.(e)

S43. Ans.(e)

S44. Ans.(d)

Sol. We can't find the exact relation

S45. Ans.(e)

Sol. With the help of both statements, we can find the required answer.



Solutions (46-48):

Numbers	Boxes
5	Blue
4	White
3	Orange
2	Pink
1	Black

S46. Ans.(d)

S47. Ans.(c)

S48. Ans.(b)

Solutions (49-50):

V > Z > Y > W > U > X

S49. Ans.(a)

S50. Ans.(e)

S51. Ans.(b)

Sol. Southeast

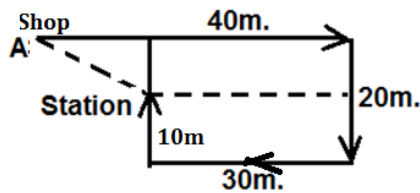

S52. Ans.(a)

Sol. 100m

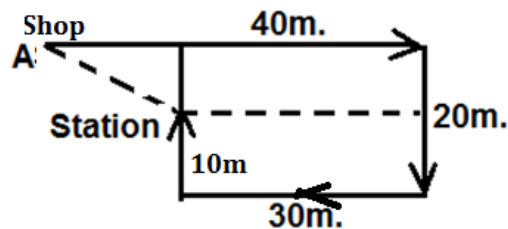

S53. Ans.(c)

Sol. $\sqrt{2^2 + 5^2} = \sqrt{4 + 25} = \sqrt{29}$

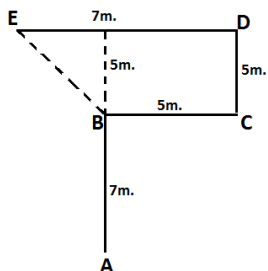

adda247
test series



LAKSHMI VILAS

BANK PO 2019

5 FULL LENGTH MOCKS

VALIDITY : 1 MONTH

S54. Ans.(e)

Sol.

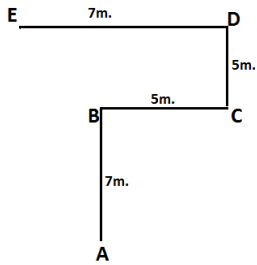

S55. Ans.(c)

Sol. $\sqrt{5^2 + 5^2} = \sqrt{50} = 5\sqrt{2}$

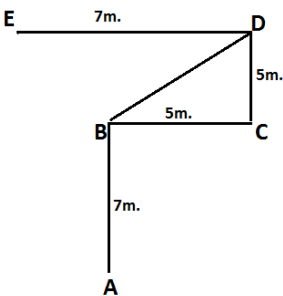

Solutions (56-60):

This coding decoding question is based on the latest pattern, following logic are applied in this question to decode the code.

(i) The first number of the code represents the numeric value of 1st alphabet of the given word. (A=1, B=2.....Z=26)

(ii) If the number of letters in the word is even then “#” symbol is used and if the number of letters in the word is odd then “&” symbol is used.

(iii) The number at the end of the code is the numeric value of the opposite alphabet of the last letter in the given word.

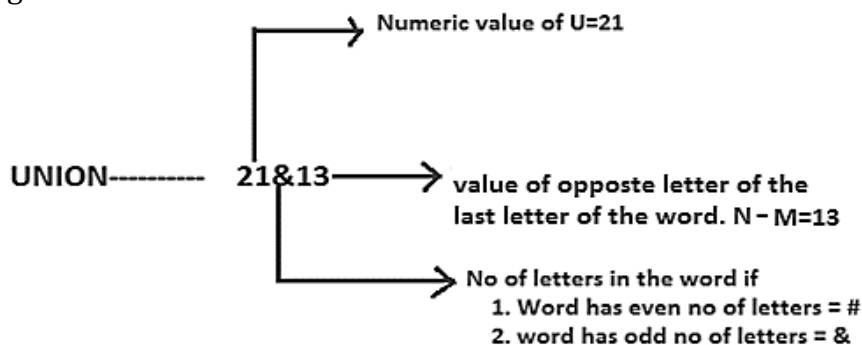

S56. Ans.(b)

S57. Ans.(c)

S58. Ans.(d)

S59. Ans.(e)

S60. Ans.(a)

Solution (61-65):

<u>Student</u>	<u>Class</u>	<u>Colour</u>
Robin	5 th	Green
Priya	9 th	Yellow
Kevin	8 th	Red
Monu	3 rd	Pink
Sem	6 th	Brown
Tom	11 th	Black
Rohan	2 nd	White

S61. Ans.(b)**S62. Ans.(a)****S63. Ans.(c)****S64. Ans.(e)****S65. Ans.(d)****Solutions (66-70):**

Students let us understand the Logic behind this Question and let's understand how to solve it. As a first step let's first understand the logic behind the Output. If you will see the final output you will observe the following:

(i) The machine rearranges one word and one number in each step.

(ii) The words are arranged in descending order based on the number of vowels in the given word. If two words contain the same number of vowels, then they are arranged in alphabetical order from left to right in each step.

(iii) While the numbers are arranged in decreasing order from left to right alternatively, even number first, followed by prime number alternatively.

Now lets take the arrangement given in the Question

Input: rock 31 rain 13 40 stock 86 takes 72 demotion worship 29

Step I: demotion rock 31 rain 13 40 stock takes 72 worship 29 86

Step II: demotion rain rock 13 40 stock takes 72 worship 29 86 31

Step III: demotion rain takes rock 13 40 stock worship 29 86 31 72

Step IV: demotion rain takes worship rock 13 40 stock 86 31 72 29

Step V: demotion rain takes worship rock stock 13 86 31 72 29 40

Step VI: demotion rain takes worship rock stock 86 31 72 29 40 13

S66. Ans.(b)**S67. Ans.(b)****S68. Ans.(b)****S69. Ans.(a)****S70. Ans.(e)**

S71. Ans.(e)

Sol. $P > N > K > O > I > M > L > J$

S72. Ans.(c)

Sol. $P > N > K > O > I > M > L > J$

S73. Ans.(a)

Sol. $P > N > K > O > I > M > L > J$

Solution (74-75):

$C/E > E/C > B > A > D > F$

S74. Ans.(e)

S75. Ans.(a)

Solutions (76-80):

Box	Colour
O	Black
K	Yellow
M	Violet
N	Brown
L	Pink
G	Blue
J	White

S76. Ans.(b)

S77. Ans.(c)

S78. Ans.(a)

S79. Ans.(c)

S80. Ans.(e)

Solutions (81-85):

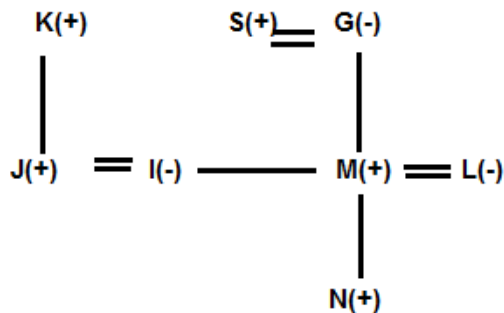
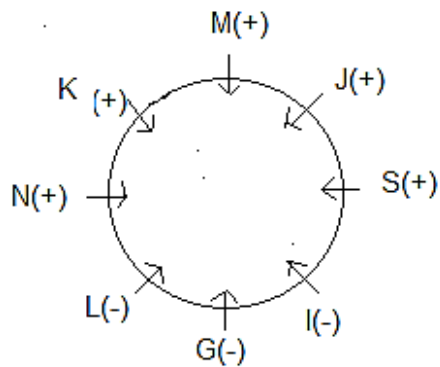

adda247
test series

Prime

IBPS IT OFFICER 2018-19

MAINS

10 Full Length Mocks
IT Professional Knowledge E-Book

S81. Ans.(a)

S82. Ans.(c)

S83. Ans.(b)

S84. Ans.(b)

S85. Ans.(c)

S86. Ans.(c)

Sol. I. $Q > V$ (false)

II. $V \geq Q$ (false)

S87. Ans.(e)

Sol. I. $B > T$ (true)

II. $C \geq D$ (true)

S88. Ans.(a)

Sol. I. $O > L$ (true)

II. $R > E$ (false)

S89. Ans.(b)

Sol. I. $A > C$ (false)

II. $D > B$ (true)

S90. Ans.(d)

Sol. I. $Q \geq P$ (false)

II. $E \geq H$ (false)

Solutions (91-95):

Floors	Persons
8	J
7	N
6	H
5	K
4	I
3	G
2	M
1	L



S91. Ans.(d)

S92. Ans.(d)

S93. Ans.(b)

S94. Ans.(b)

S95. Ans.(d)

Solutions (96-100):

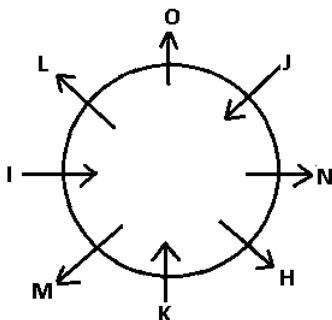

S96. Ans.(b)
 S97. Ans.(b)
 S98. Ans.(c)
 S99. Ans.(b)
 S100. Ans.(b)

S101. Ans.(e)
 Sol.

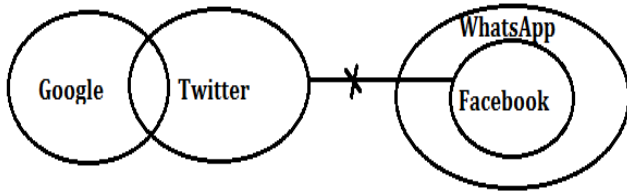

S102. Ans.(a)
 Sol.

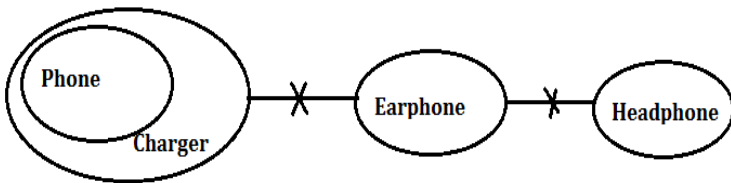

S103. Ans.(d)
 Sol.

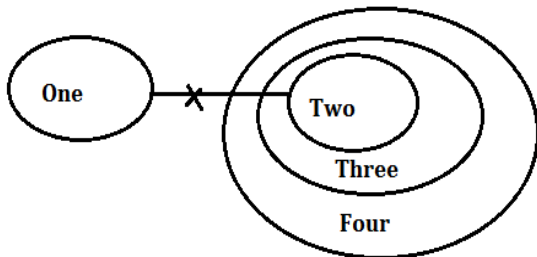

S104. Ans.(a)
 Sol.

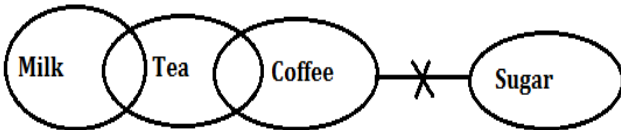

S105. Ans.(b)
 Sol.

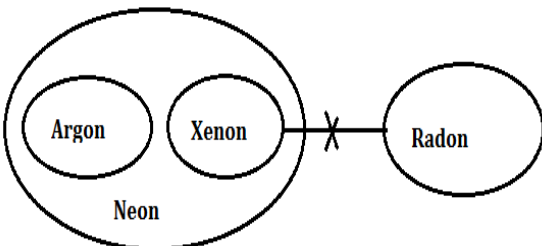

Special Offer

adda247
test series

**KARNATAKA
BANK PO 2019**

SCALE-I

20 Total Tests

- 5 Full Length Mocks
- 15 Practice

S106. Ans.(a)

Sol. I. $N > O$ (True)

II. $L = W$ (False)

S107. Ans.(b)

Sol. I. $C \geq L$ (False)

II. $M < L$ (True)

S108. Ans.(e)

Sol. I. $G > N$ (True)

II. $G > A$ (True)

S109. Ans.(e)

Sol. I. $O < M$ (True)

II. $A > O$ (True)

S110. Ans.(d)

Sol. I. $J > S$ (False)

II. $J < S$ (False)

S111. Ans.(a)

Sol.

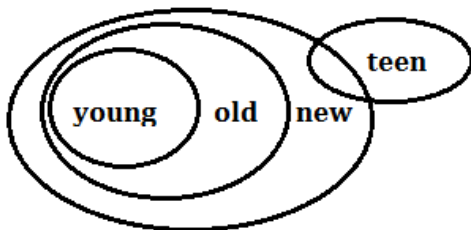

S112. Ans.(b)

Sol.

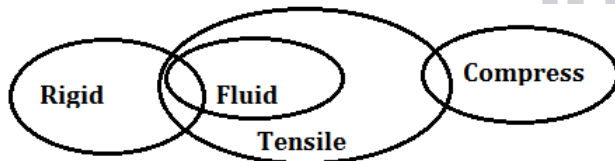

S113. Ans.(b)

Sol.

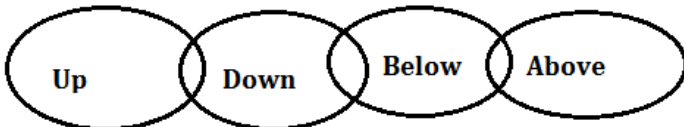

S114. Ans.(d)

Sol.

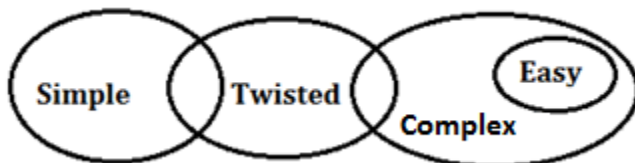

S115. Ans.(a)

Sol.

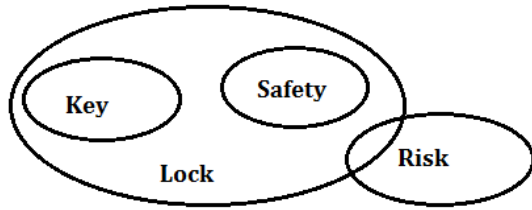

Solutions (116-120):

Box	Cities
M	Jaipur
P	Kolkata
N	Lucknow
Q	Pune
S	Mumbai
O	Delhi
R	Bhopal

S116. Ans.(b)

S117. Ans.(d)

S118. Ans.(a)

S119. Ans.(c)

S120. Ans.(e)

Solutions (121-125):

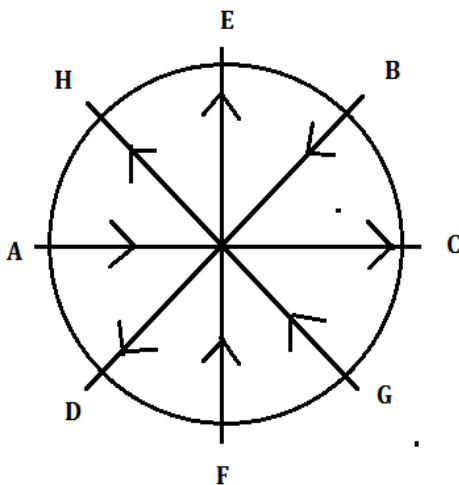

S121. Ans.(d)

S122. Ans.(e)

S123. Ans.(a)

S124. Ans.(a)

S125. Ans.(e)



Special Offer

 **adda247**
test series

 **IBPS CLERK 2018**
MAINS

with Video Solutions

• 10 FULL-LENGTH MOCKS
Bilingual

S126. Ans.(b)

Sol.

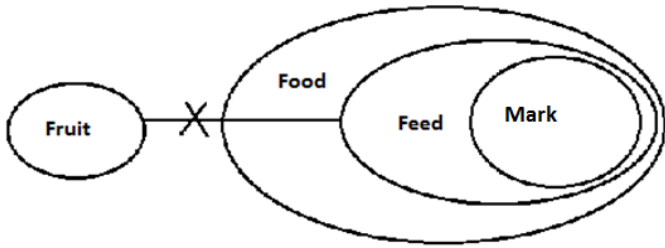

S127. Ans.(d)

Sol.

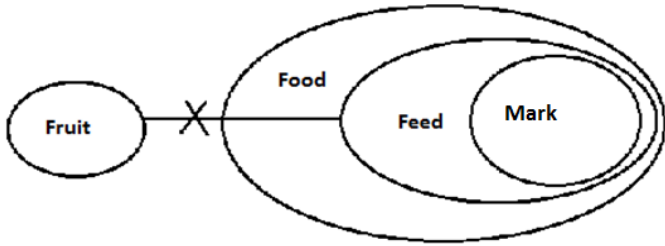

S128. Ans.(b)

Sol.

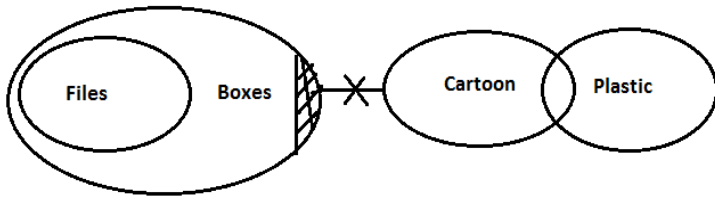

S129. Ans.(a)

Sol.

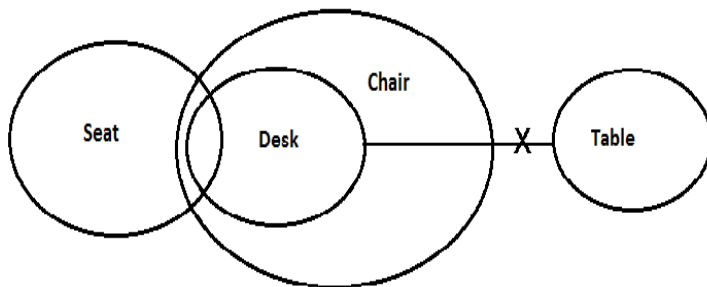

S130. Ans.(c)

Sol.

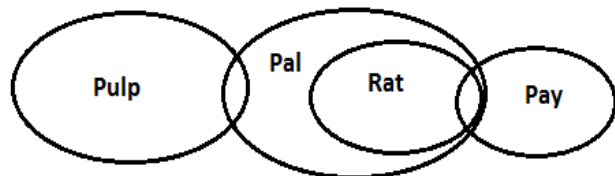

Solutions (131-132):

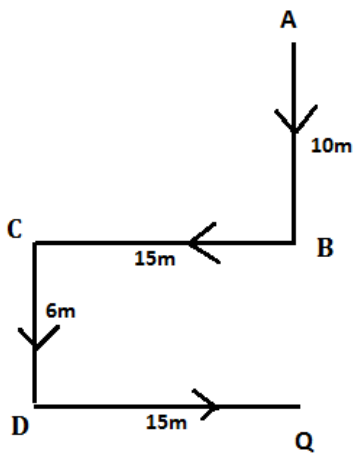

S131. Ans.(e)

S132. Ans.(a)

Solutions (133-135):

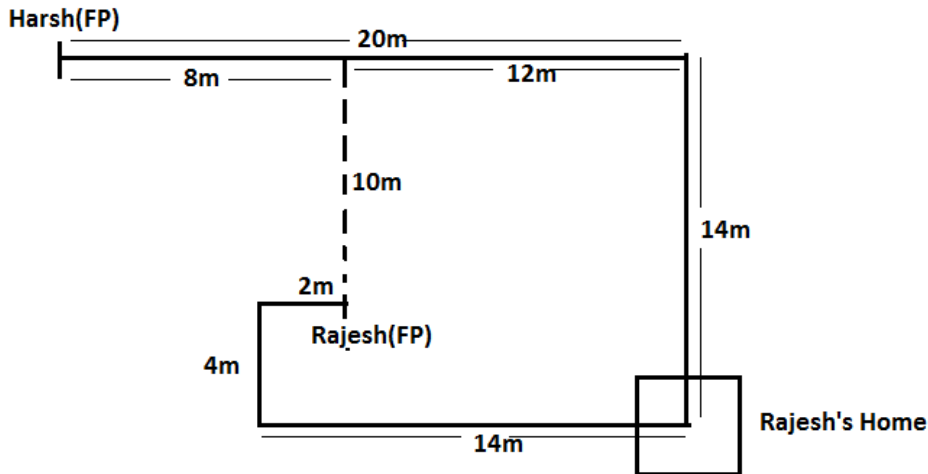

S133. Ans.(e)

S134. Ans.(e)

S135. Ans.(d)

S136. Ans.(a)

Sol. $71\#9\$A+8E3=612*\%0<5U\delta$

S137. Ans.(c)

S138. Ans.(e)

Sol. 10TH to the left of 18th from the left = $(18-10)=8$ th from the left = W

S139. Ans.(a)

S140. Ans.(b)

Solutions (141-145):

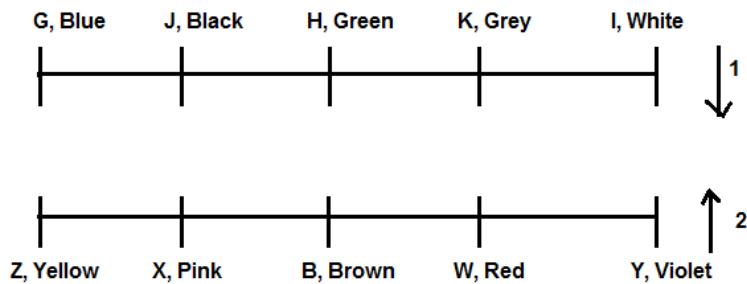

S141. Ans.(a)

S142. Ans.(d)

S143. Ans.(b)

S144. Ans.(d)

S145. Ans.(a)

Solutions (146-150):

In this new pattern Input-Output question only one word and one number is arranged in each step. Let us understand the logic behind it- In each step the words are arranged from the left end while the numbers are arranged from the right end.

For words- words are arranged alphabetical order (English dictionary) from left end with each consonant of word is replaced by its second succeeding letter according to alphabetical series while there will be no change in each vowel of the word and same will be followed in further steps.

For numbers- Numbers are arranged in descending order from right end in such a way that each number is replaced by addition of both the digits of the number.

Input- world 66 tourism 39 destination 43 excellence 25

Step-I: feuvipaviop world tourism 39 43 excellence 25 12

Step-II: ezeennepee feuvipaviop world tourism 39 25 12 7

Step-III: voutiuo ezeennepee feuvipaviop world 25 12 7 12

Step-IV: yotnf voutiuo ezeennepee feuvipaviop 12 7 12 7

S146. Ans.(d)

S147. Ans.(c)

S148. Ans.(a)

S149. Ans.(d)

S150. Ans.(b)

Advertisement for Adda247 test series. It features the Adda247 logo, the text "adda247 test series", and "अब हिंदी में" (Now in Hindi). Below that is the IBPS logo and "आईबीपीएस क्लर्क 2018 मैन्स" (IBPS Clerk 2018 Mains). At the bottom, it says "विडियो सलूशन के साथ" (With video solutions) and "10 फुल लेंगथ मॉक" (10 full length mock tests).