



adda247 publications

BOOKS

A grid of 48 book covers from Adda247 Publications, organized in 6 rows and 8 columns. The books cover various exam categories:

- Row 1:** "THE CRACKER" PRACTICE BOOK FOR GEOMETRY (800+ questions); 100 SSC CGL (10,000+ questions); "THE CRACKER" PRACTICE BOOK FOR MENSURATION (850+ questions); 20+ SSC CGL TIER-II / MAINS 2015-18 (3100 questions); Ace SSC ARITHMETIC; Ace SSC ADVANCED MATHS.
- Row 2:** Ace SSC GENERAL INTELLIGENCE & REASONING; Ace SSC ENGLISH LANGUAGE & COMPREHENSION BOOK; Ace SSC GENERAL AWARENESS; INSURANCE EXAMS PREVIOUS YEARS' PAPER 2016-2018 (1800+ questions); BANK PO & CLERK PRELIMS PREVIOUS YEARS' PAPERS BOOK (2400+ questions); BANK PO | CLERK MAINS PREVIOUS YEARS' PAPERS (2000+ questions).
- Row 3:** "THE CRACKER" BANK MAINS EXAMS (2000+ questions); 20+ IBPS PO PRELIMS 2018 MOCK PAPER (2200 questions); 20+ IBPS CLERK CWE-VIII IBPS CLERK PRELIMS 2018 MOCK PAPERS (2300 questions); 50+ BANK PO & CLERK 2016-18 (6800+ questions); A COMPLETE BOOK OF PUZZLE & SEATING ARRANGEMENT (2500+ questions); A COMPLETE BOOK OF DATA INTERPRETATION & ANALYSIS (2000+ questions).
- Row 4:** Ace IT OFFICER Professional Knowledge; A Guide to Crack BANK EXAMS INTERVIEWS (JOB INTERVIEW); Ace BANKING & STATIC AWARENESS; Ace REASONING; Ace QUANT; Ace ENGLISH.

Visit: publications.adda247.com & store.adda247.com
For any information, mail us at publications@adda247.com

Solutions

Solutions (1-5):

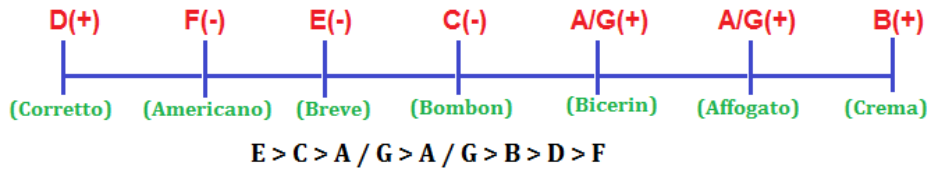

S1. Ans.(a)

Sol.

S2. Ans.(d)

Sol.

S3. Ans.(d)

Sol.

S4. Ans.(d)

Sol.

S5. Ans.(c)

Sol.

Solutions (6-7):

Sol.

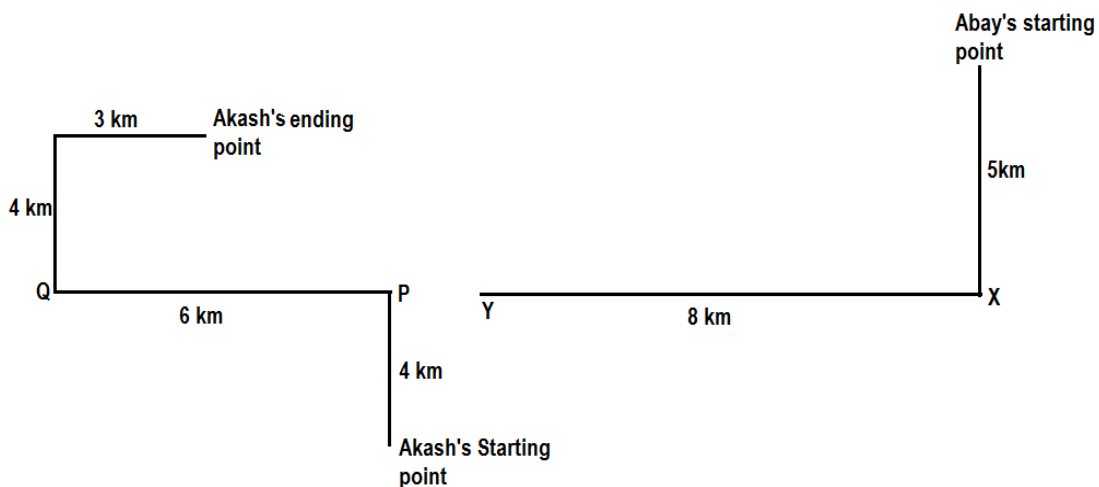

S6. Ans.(c)

S7. Ans.(e)

Solutions (8-12):

S8. Ans.(c)

Sol.

Shelve	BOX
5	Y
4	X
3	V
2	W
1	Z

S9. Ans.(c)

Sol. By using (I) and (III) statement we can find the code of world is- 'mn'.

S10. Ans.(e)

Sol.

S11. Ans.(a)

Sol. Zebpay is coded as AZ12

In the coded language:

1st letter is coded as the reverse of the first letter of the word

2nd letter is coded as the succeeding letter of the last letter of the word according to alphabetic series.

Number is coded by multiplying the total number of letter in the word by 2.

S12. Ans.(e)

Sol.

Solutions (13-15):

S13. Ans. (d)

Sol.

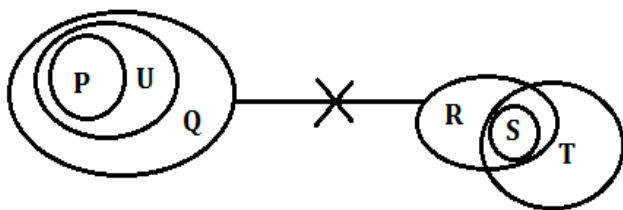

S14. Ans. (a)

Sol.

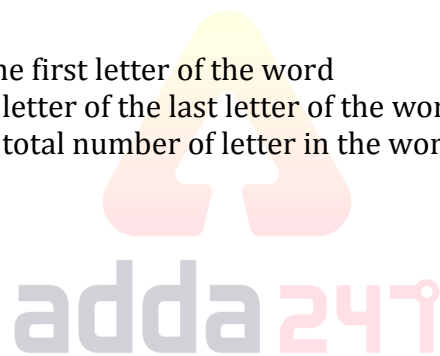
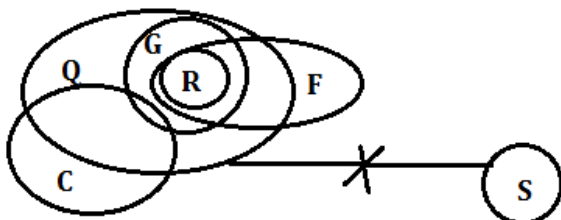

**LIC ADO 2019
PRIME PACKAGE**

TOTAL VACANCIES 8550+

65+ TOTAL TESTS

- 20 Full Length Mocks
- 25 Section wise Practice Sets
- 20 Topic wise Practice Sets
- 2 Previous Years' Papers
- Insurance Knowledge eBook

BILINGUAL

S15. Ans. (d)

Sol.

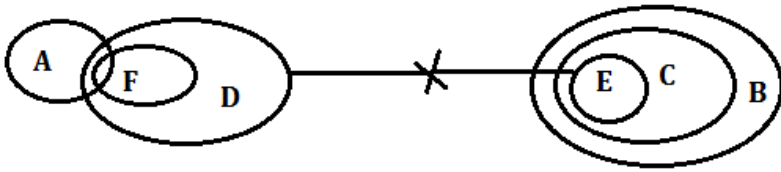

Solutions (16-18):

Sol.

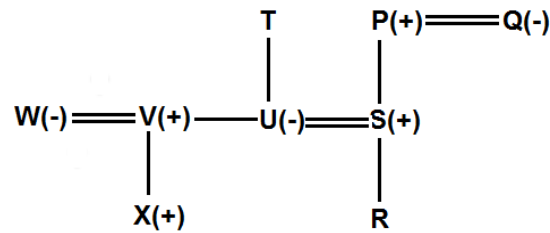

S16. Ans.(e)

Sol.

S17. Ans.(c)

Sol.

S18. Ans (b)

Sol.

Solutions (19-21):

S19. Ans.(e)

Sol.

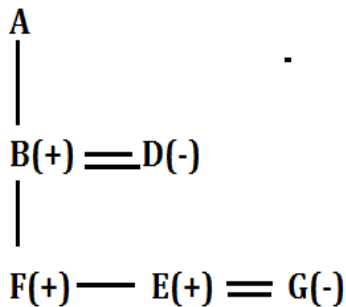

LIC AAO MAINS
PRIME 2019
GENERALIST
45+ TOTAL TESTS

- 10 Full Length Mocks
- 15 Section Wise Sets
- 20 Topic Wise sets
- 2 Previous Years Papers
- eBooks

BILINGUAL

S20. Ans.(d)

Sol.

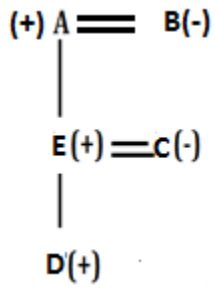

S21. Ans (c)

Sol.

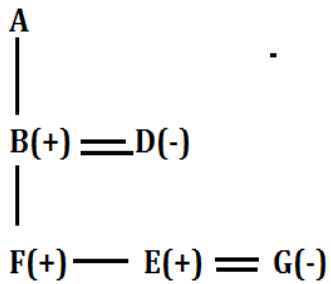

S22. Ans.(e)

Sol.

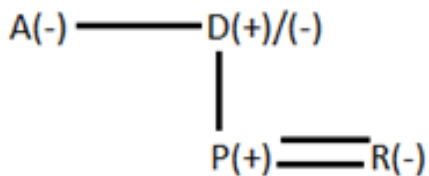

S23. Ans.(e)

Sol.

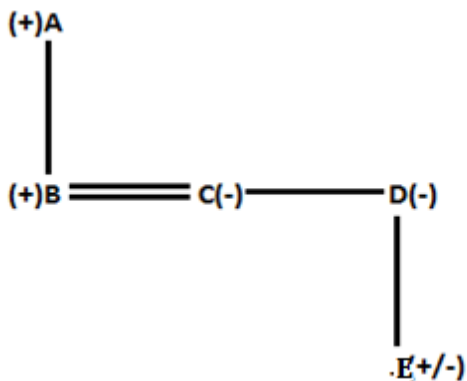

**BANK & INSURANCE
2019**

PREMIUM PACKAGE

Mocks | Practice sets | eBooks

1000 Total Tests

500 + eBooks

Validity: 12 Months | Bilingual

S24. Ans.(b)

Sol.

Day	Person
Tuesday	A
Wednesday	C
Thursday	E
Friday	D
Saturday	B

S25. Ans.(a)

Sol.

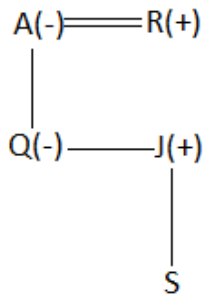

S26. Ans(d)

Sol. Since we don't get the position of any of the person from both the ends before or after interchanging then it is not possible to answer how many persons are there in the row.

Solutions (27-28):

Sol. C > A > E > B > D > F

S27. Ans.(a)

Sol.

S28. Ans.(e)

Sol.

Solution (29-30):

Boxes	Colours
B	Orange
D	-
C	Blue
E	Green
F	Red
A	-

So, it is clear that, Box C is of Blue color.

> > > >B/E > B/E
12 10

- ✓ 30 Full Length Mocks
- ✓ 7 + Previous Years Papers
- ✓ 30 Section Wise Practice sets
- ✓ 20 Topic wise sets
- ✓ eBooks

Total Number of toffees in box B+A= 31

Difference in Number of toffees in box F-E=7

Number of toffees in box F+8= Box contains highest number of toffees

$C > D > A > F > B > E$
25 21 19 17 12 10

So, Box C of Blue color contain 25 toffees.

S29 Ans. (c)

S30. Ans (e)



LIC ADO 2019 PRIME PACKAGE

TOTAL VACANCIES 8550+

65+ TOTAL TESTS

- 20 Full Length Mocks
- 25 Section wise Practice Sets
- 20 Topic wise Practice Sets
- 2 Previous Years' Papers
- Insurance Knowledge eBook

BILINGUAL

BANK & INSURANCE 2019

PREMIUM PACKAGE

Mocks | Practice sets | eBooks

1000 Total Tests
500 + eBooks

Validity: 12 Months | Bilingual

LIC AAO MAINS PRIME 2019

GENERALIST

45+ TOTAL TESTS

- 10 Full Length Mocks
- 15 Section Wise Sets
- 20 Topic Wise sets
- 2 Previous Years Papers
- eBooks

BILINGUAL